



CLM-U300S 系列概述

一. 电源规格 Power supply specification:

电源型号 (MODEL)	输入 (VAC)	输出 (VDC)	保护功能 (PROTECTION)	尺寸 (SIZE) MM
CLM-U300S12	100~240VAC	12V/22A	SCP/OCP/OVP/OTP	255MM*68MM*38MM
CLM-U300S24	100~240VAC	24V/12.5A	SCP/OCP/OVP/OTP	255MM*68MM*38MM
CLM-U300S28	100~240VAC	28V/11A	SCP/OCP/OVP/OTP	255MM*68MM*38MM
CLM-U300S36	100~240VAC	36V/8.3A	SCP/OCP/OVP/OTP	255MM*68MM*38MM
CLM-U300S48	100~240VAC	48V/6.25A	SCP/OCP/OVP/OTP	255MM*68MM*38MM
CLM-U300S52	100~240VAC	52V/5.8A	SCP/OCP/OVP/OTP	255MM*68MM*38MM

二. 系列特征 Features:

- 全球范围 AC 输入:
Universal AC input: 90~277VAC, 300 VAC MAX, 47~63HZ
- 小薄体积
Slim volume
- 内建有源 PFC 功率因数校正:
Built-in Active PFC: PF>0.96@230VAC Full Load(满载)
- 金属外壳
Metal case
- 防水 LED 驱动, IP 65 防护等级:
Waterproof LED driver: Meet IP 65
- 恒压+恒流工作模式
C.V+C.C Work mode
- 三合一调光功能:
3 in 1 dimming function: (1~10vdc, 10V pwm, R10kΩ~100kΩ)
- 保护功能:
Protection: SCP/OCP/OVP/OTP
- 100%全负载老化测试
100% full load burn-in test
- 三年保质期
3 years warranty



三. 产品外观 Appearance of product:

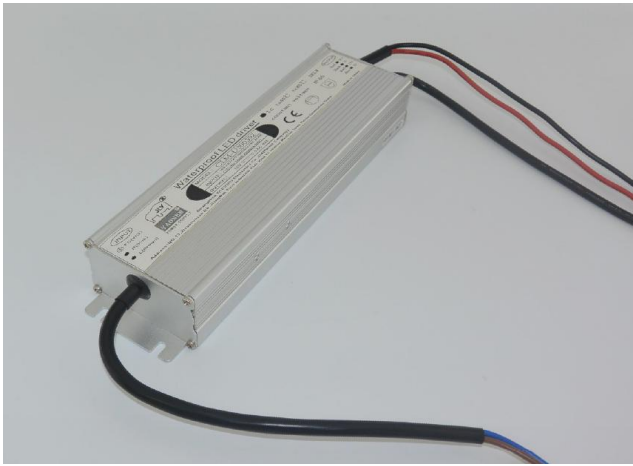

Net weight (重量) : 1300g (灌胶)

INPUT (输入) : 18# AWG UL1015*3P L=30CM (棕、蓝、黄绿)

OUTPUT (输出) : 14# AWG UL1015*2P (红、黑)

Adjust the light(调光线): $\Phi 6$ 护套-24# AWG(1007)-4 芯红白黄蓝线 L=33CM 上锡 3mm 和 5mm

四. 工作温度, 输出功率曲线以及负载曲线图:

Temperature- load curve

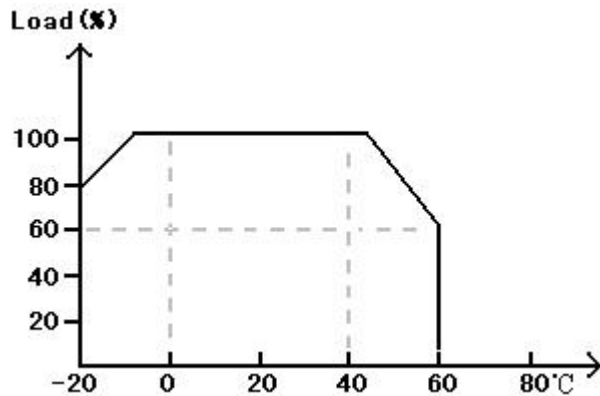

Input voltage- load curve

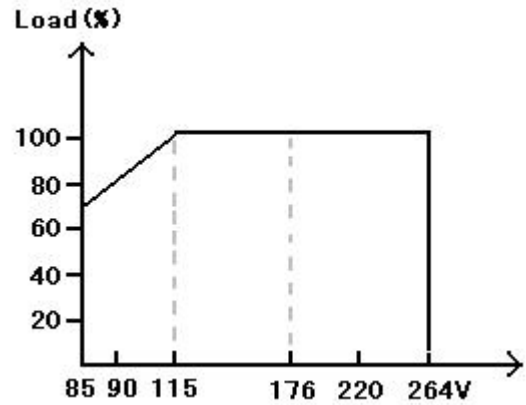

调光操作 Dimming operation:

- ① 在 D+/D-连接电阻 (10 k Ω -100 k Ω) ;1-10Vdc 电压; 10V PWM 信号进行调光。
- ② D+与 V+ 不能相连。

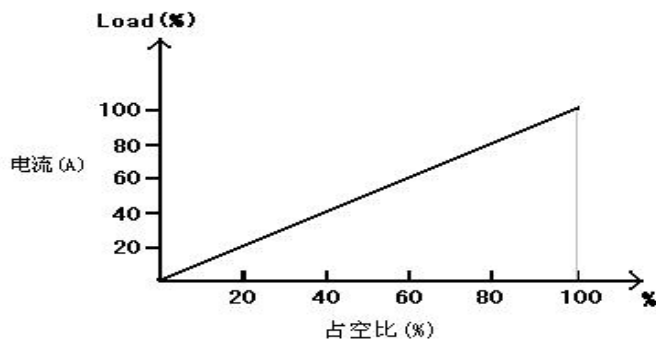
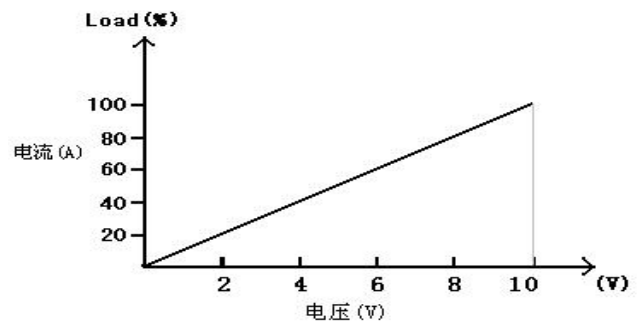
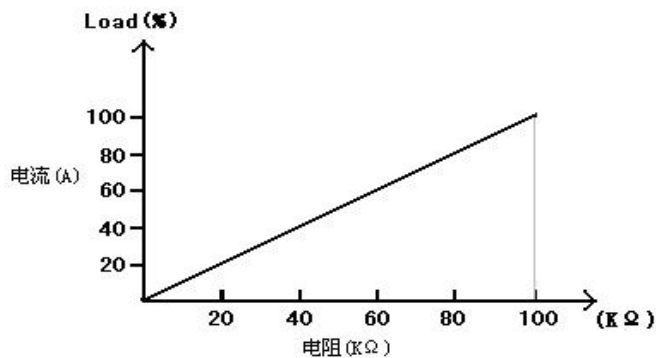



五. 测试标准:

EMC DATA

1、 EMI

RE/CE	EN55015 CLASS B
Harmonics Current	EN61000-3-2 CLASS C

2、 EMS

ESD	EN61000-4-2	Air:8KV Contact:4KV	Criteria A
RS	EN61000-4-3	80MHz~1GHz 3V/m	Criteria A
EFT	EN61000-4-4	5KHz AC=1KV	Criteria A
Surge Test	EN61000-4-5	1.2/50us AC:±2KV 8/50us	Criteria A
CS	EN61000-4-6	0.15MHz-80MHz 3V/m	Criteria A
Voltage dips	EN61000-4-8	30% 10ms 60% 100ms >95% 5000ms	Criteria A
Power Frequency Magnetic Field	EN61000-4-11	50Hz 30A/m	Criteria A
RF Electromagnetic Field pulse modulated	ENV50204	900±5MHz 200Hz 3V/m, 50%Duty cycle	Criteria A



六. 安装尺寸:

unit: mm

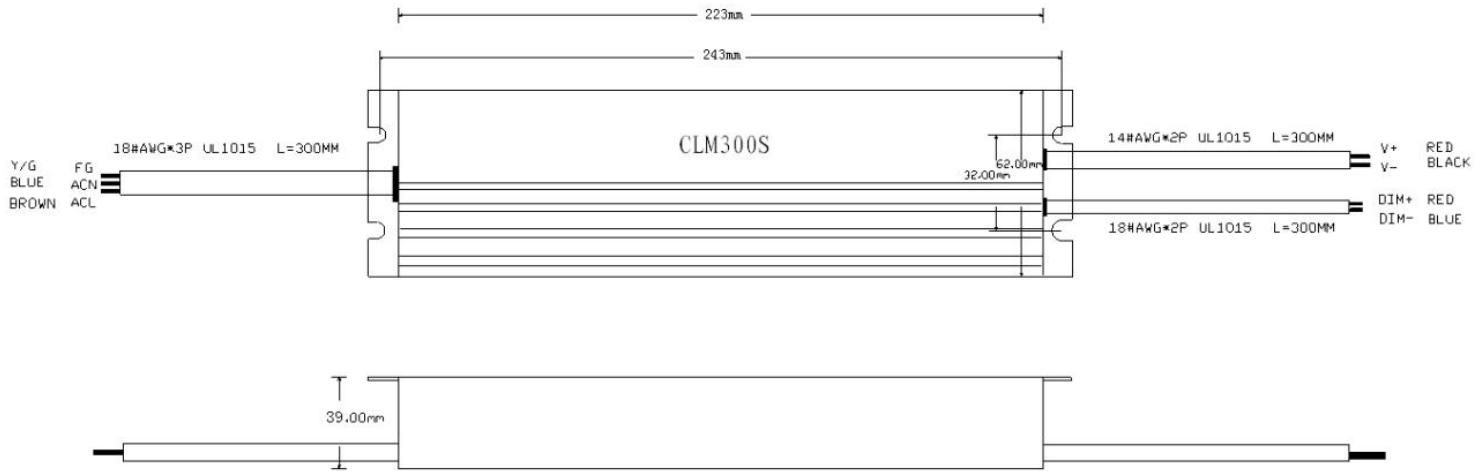

auxiliary cooler

size:300*300*3.0 (MM)

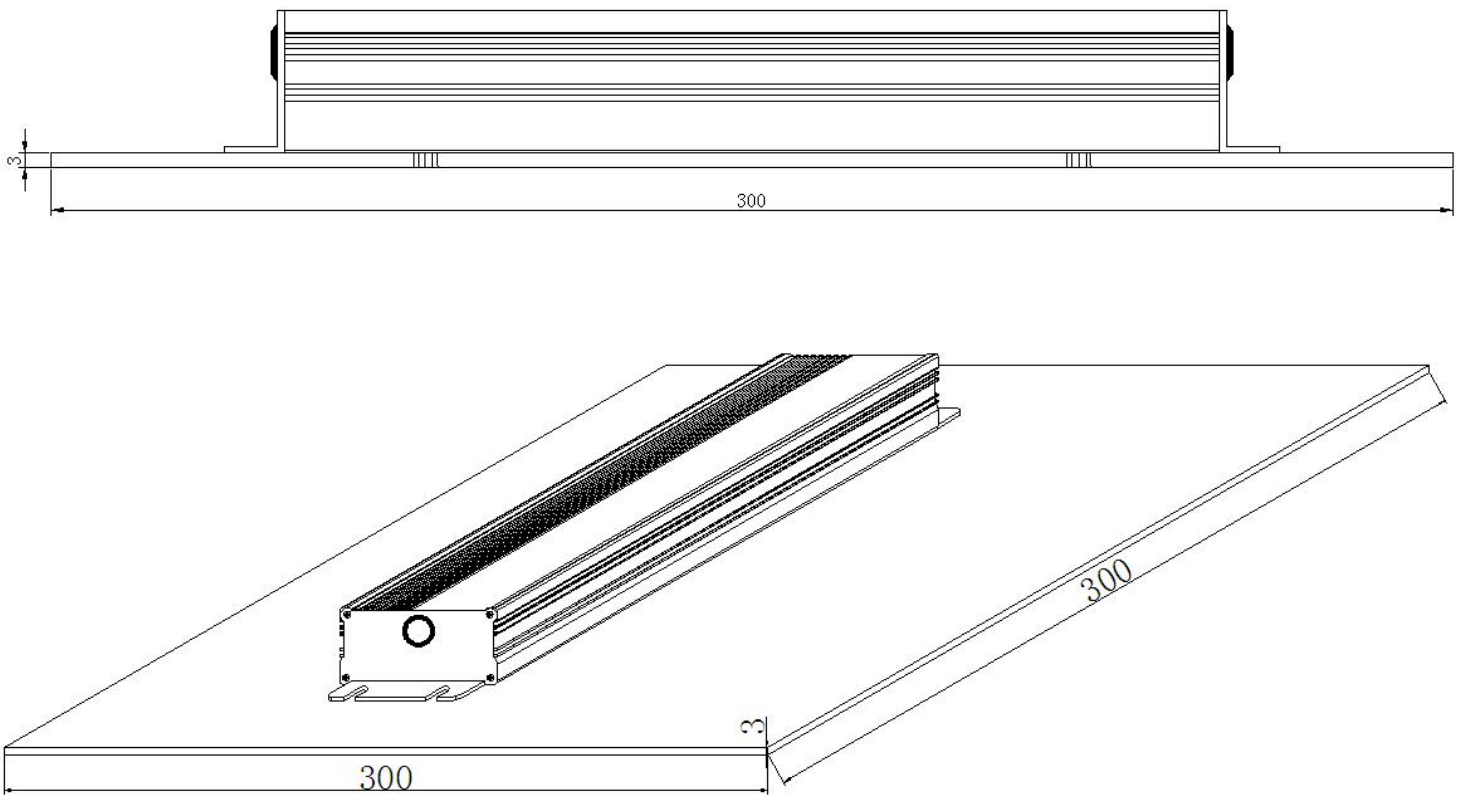



七. 标签:

Spec Label

<p>INPUT</p> <p>FG(Y/G)</p> <p>N(Blue)</p> <p>L(Brown)</p>	 POWER SUPPLY	<p>Waterproof LED driver</p> <p>● tc ta40°C tc85°C SELV</p> <p>constant voltage IP 65</p>	<p>OUTPUT</p> <p>Red ● V+</p> <p>Black ● V-</p> <p>Red ● D+</p> <p>Blue ● D-</p>
<p>MODEL: CLM-U300S52</p> <p>INPUT: 100-240VAC 50/60Hz 3.8A MAX (277~for North America only)</p> <p>OUTPUT: 52V --- 5.8A MAX</p>		 	
<p>Guangzhou YARUIPU Electronics Co., Ltd(Parent Company)</p> <p>Address: NO.13, 2transverse RD. JianqNan First Industrial Park Xinq Ye avenue NanCun Town Panyu Guangzhou China</p>			<p>Made in China</p>

八. 包装:

Packing

unit: mm

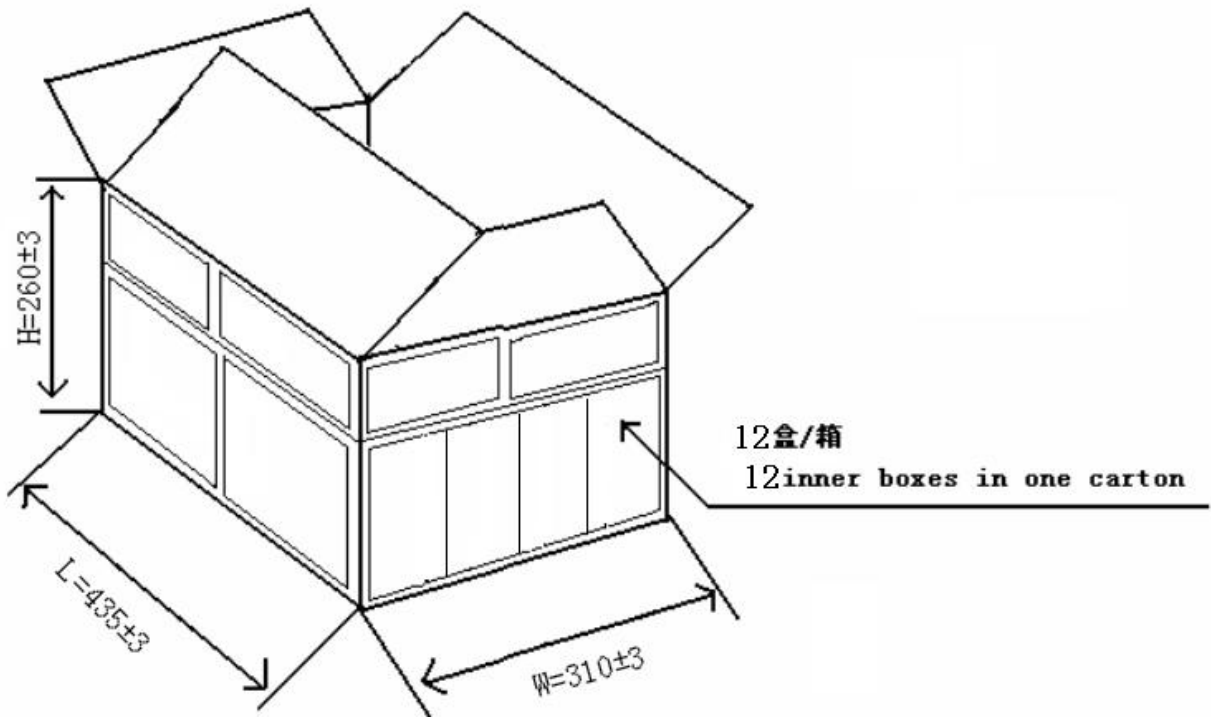

Solid

