



NCH150S 系列概述

一. 电源规格:

电源型号 (MODEL)	输入 (VAC)	输出 (VDC)	保护功能 (PROTECTION)	尺寸 (SIZE) MM
NCH150S-001	100~240VAC	12V/10A	SCP/OCP/OVP/OTP	116mm*60mm*35mm
NCH150S-002	100~240VAC	24V/6.3A	SCP/OCP/OVP/OTP	116mm*60mm*35mm
NCH150S-003	100~240VAC	28V/5.3A	SCP/OCP/OVP/OTP	116mm*60mm*35mm
NCH150S-004	100~240VAC	36V/3.4A	SCP/OCP/OVP/OTP	116mm*60mm*35mm
NCH150S-005	100~240VAC	48V/3A	SCP/OCP/OVP/OTP	116mm*60mm*35mm
NCH150S-006	100~240VAC	40V/3.7A	SCP/OCP/OVP/OTP	116mm*60mm*35mm
NCH150S-007	100~240VAC	45V/3.3A	SCP/OCP/OVP/OTP	116mm*60mm*35mm
NCH150S-008	100~240VAC	20V/6A	SCP/OCP/OVP/OTP	116mm*60mm*35mm
NCH150S-009	100~240VAC	15V/8A	SCP/OCP/OVP/OTP	116mm*60mm*35mm
NCH150S-010	100~240VAC	58V/2.6A	SCP/OCP/OVP/OTP	116mm*60mm*35mm

二. 系列特征:

Features

- Universal AC input / Full range
- Built-in Active PFC
- Protections: SCP / OCP / OVP / TOP
- PF: >0.98@115VAC; >0.97@230VAC
- High efficiency, high reliability
- 100% full load burn-in test
- 1 years warranty

三. 产品外观:

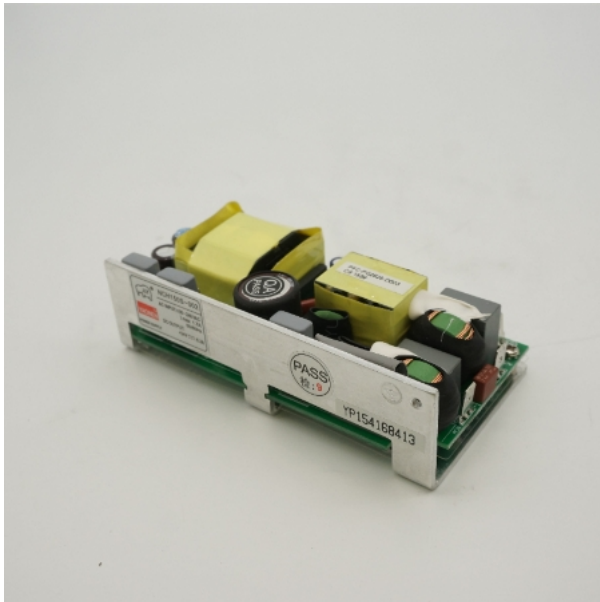

Net weight: 280g

四. 工作温度, 输出功率曲线以及负载曲线图:

Temperature- load curve

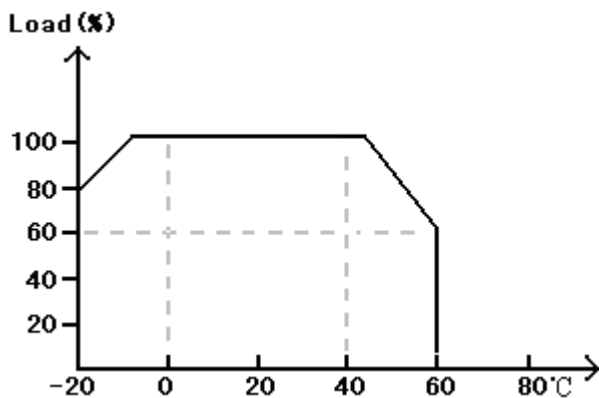

Input voltage- load curve

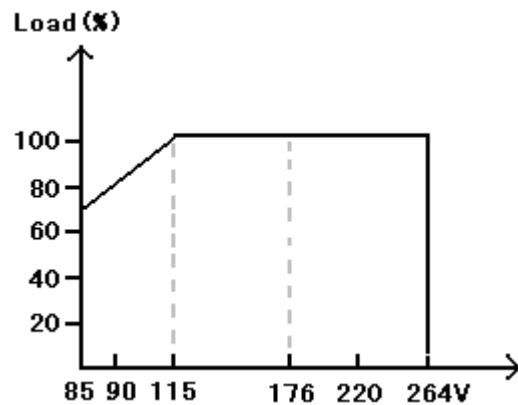

五. 测试标:

EMC DATA:

1、 EMI

RE/CE	EN55022 CLASS A
Harmonics Current	EN61000-3-2

2、 EMS

ESD	EN61000-4-2	Air:8KV Contact:4KV	Criteria A
RS	EN61000-4-3	80MHz~1GHz 3V/m	Criteria A
EFT	EN61000-4-4	5KHz AC=1KV	Criteria A
Surge Test	EN61000-4-5	1.2/50us AC:±2KV 8/50us	Criteria A
CS	EN61000-4-6	0.15MHz-80MHz 3V/m	Criteria A
Voltage dips	EN61000-4-8	30% 10ms 60% 100ms	Criteria A

		>95% 5000ms	
Power Frequency Magnetic Field	EN61000-4-11	50Hz 30A/m	Criteria A
RF Electromagnetic Field pulse modulated	ENV50204	900±5MHz 200Hz 3V/m, 50%Duty cycle	Criteria A

六. 安装尺寸:

build in dimension

unit: mm

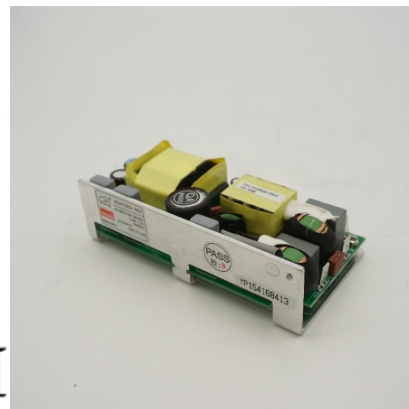
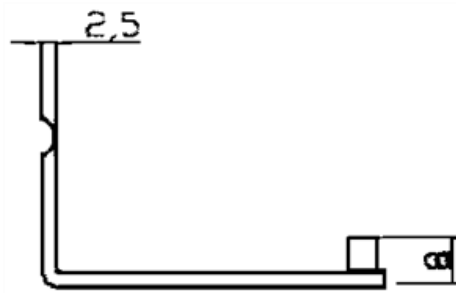
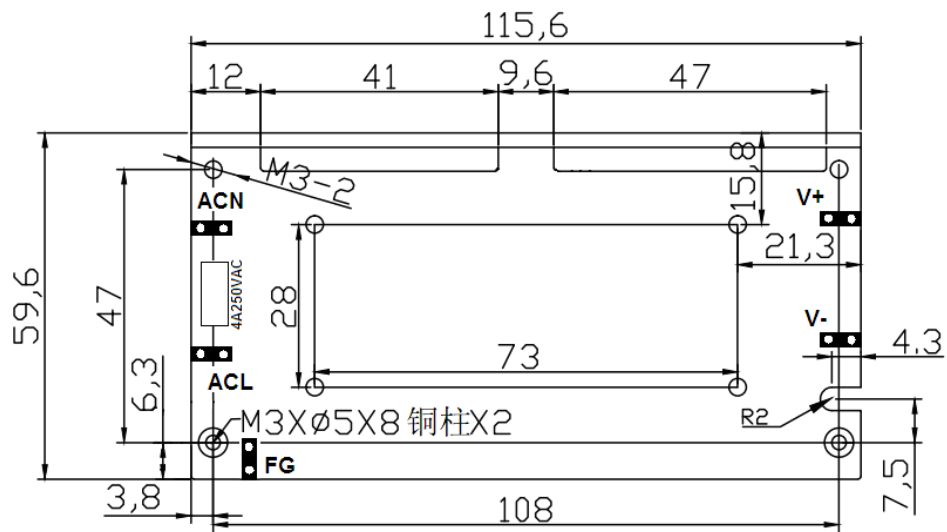
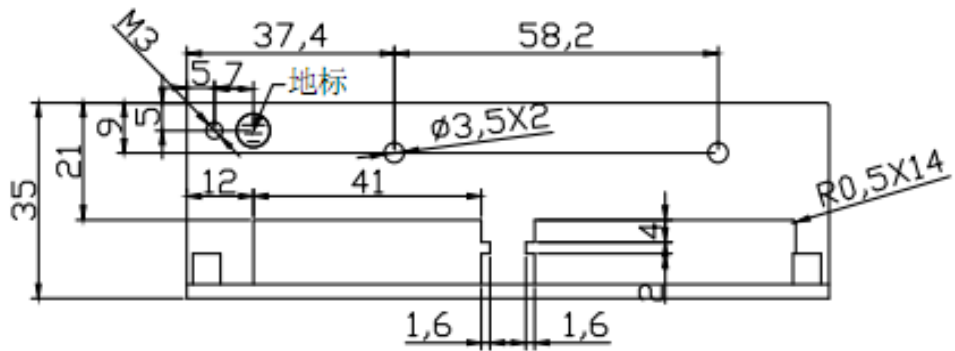



七. 标签:

Spec Label

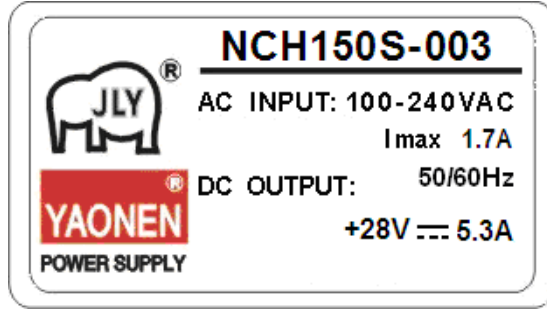

八. 包装:

Packing unit: mm

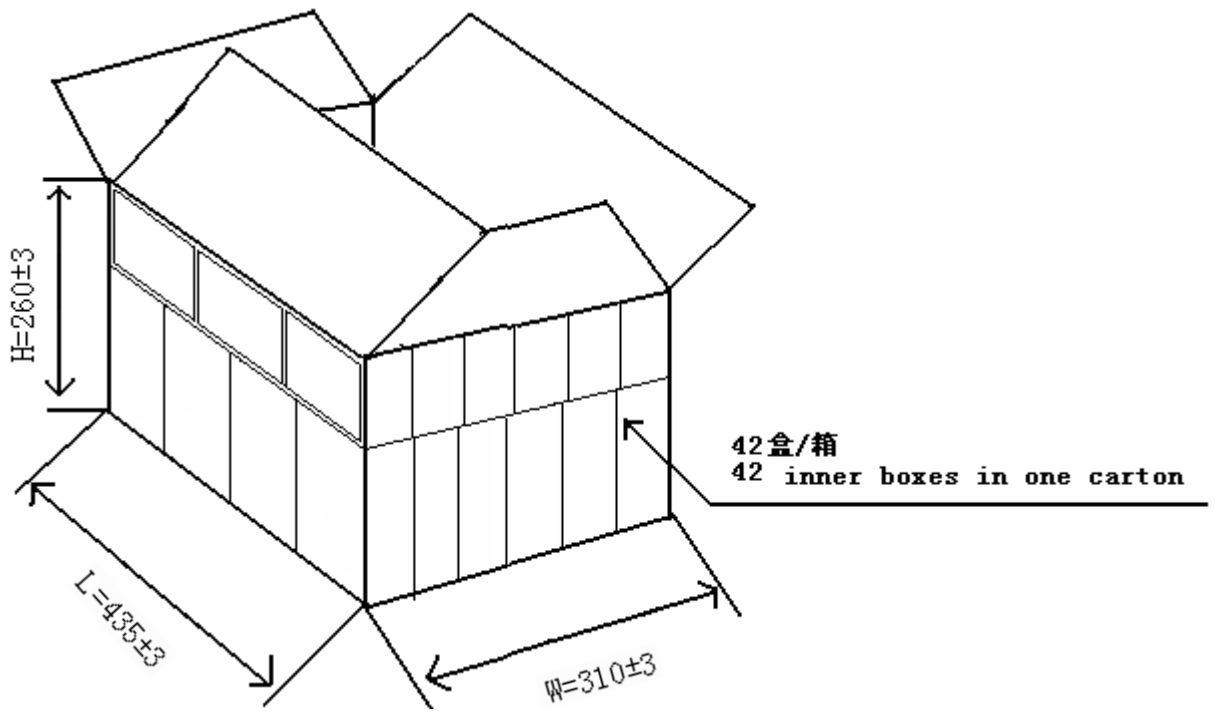

Inner Box plane

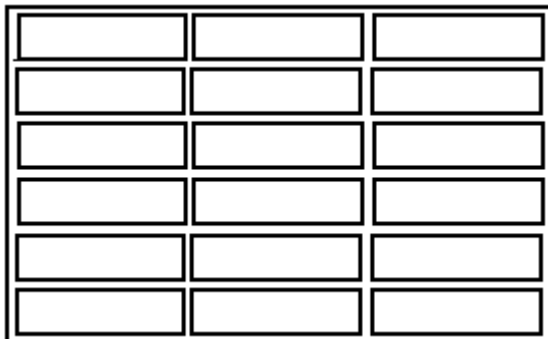

solid

