

一. 电源规格:

电源型号 (MODEL)	输入 (VAC)	输出 (VDC)	保护功能 (PROTECTION)	尺寸 (SIZE) MM
TM-U300S12	100~240VAC	12V/25A	SCP/OCP/OVP/OTP	225mm*115mm*30mm
TM-U300S24	100~240VAC	24V/12.5A	SCP/OCP/OVP/OTP	225mm*115mm*30mm
TM-U300S36	100~240VAC	36V/8.5A	SCP/OCP/OVP/OTP	225mm*115mm*30mm
TM-U300S48	100~240VAC	48V/6.25A	SCP/OCP/OVP/OTP	225mm*115mm*30mm

二. 系列特征:
Features:

Universal AC input / Full range;

Built in active PFC;

PF > 0.96 @ 230 VAC full load;

Built-in EMI filter;

Protections: SCP /OCP/ OVP/OTP;

Slim volume, High reliability, high efficiency;

Efficiency up to 90%(type);

All using 105°C long life electrolytic Capacitors;

100% full load burn-in test;

2years warranty.

三. 产品外观:

(Note: photos are for reference only)

net weight: 790g/PCS

Connection: 11P/9.5MM pitch terminal block



四. 工作温度, 输出功率曲线以及负载曲线图:

Temperature- load curve

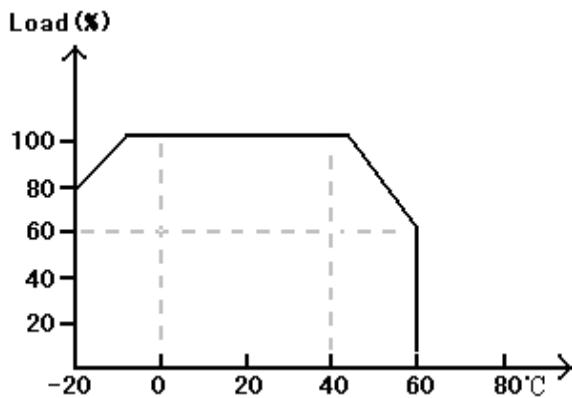

Input voltage- load curve

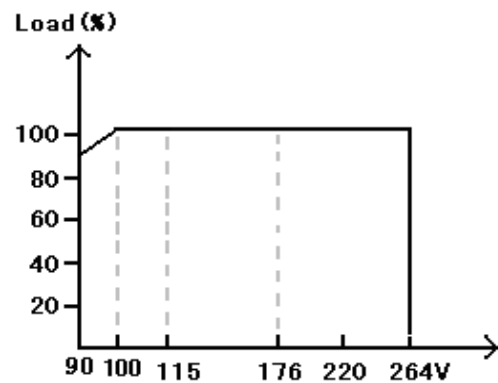

五. 测试标准:

EMC DATA:

1、 EMI

RE/CE	EN55022 CLASS A
Harmonics Current	EN61000-3-2

2、 EMS

ESD	EN61000-4-2	Air:8KV Contact:4KV	Criteria A
RS	EN61000-4-3	80MHz~1GHz 3V/m	Criteria A
EFT	EN61000-4-4	5KHz AC=1KV	Criteria A
Surge Test	EN61000-4-5	1.2/50us AC: ±2KV 8/50us	Criteria A
CS	EN61000-4-6	0.15MHz-80MHz 3V/m	Criteria A
Voltage dips	EN61000-4-8	30% 10ms 60% 100ms >95% 5000ms	Criteria A
Power Frequency Magnetic Field	EN61000-4-11	50Hz 30A/m	Criteria A
RF Electromagnetic Field pulse modulated	EN50204	900±5MHz 200Hz 3V/m, 50%Duty cycle	Criteria A

六. 安装尺寸:

build in dimension

unit: mm

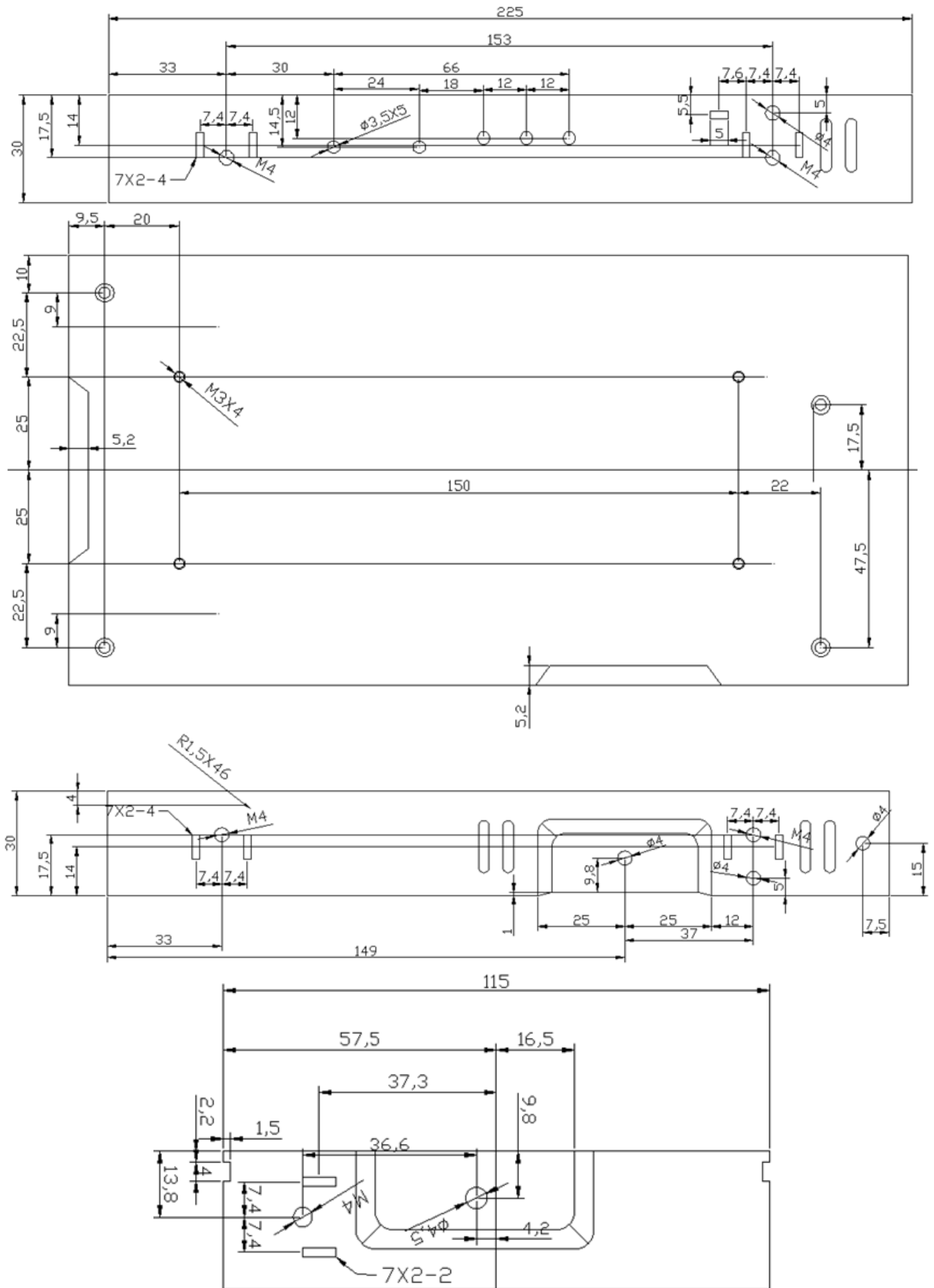



七. 标签:

Spec Label

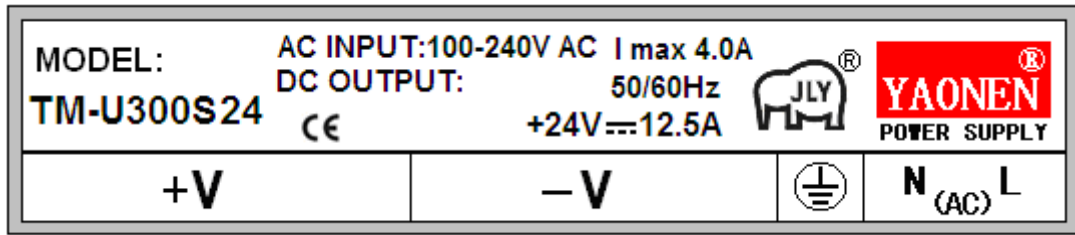

八. 包装:

Packing unit: mm

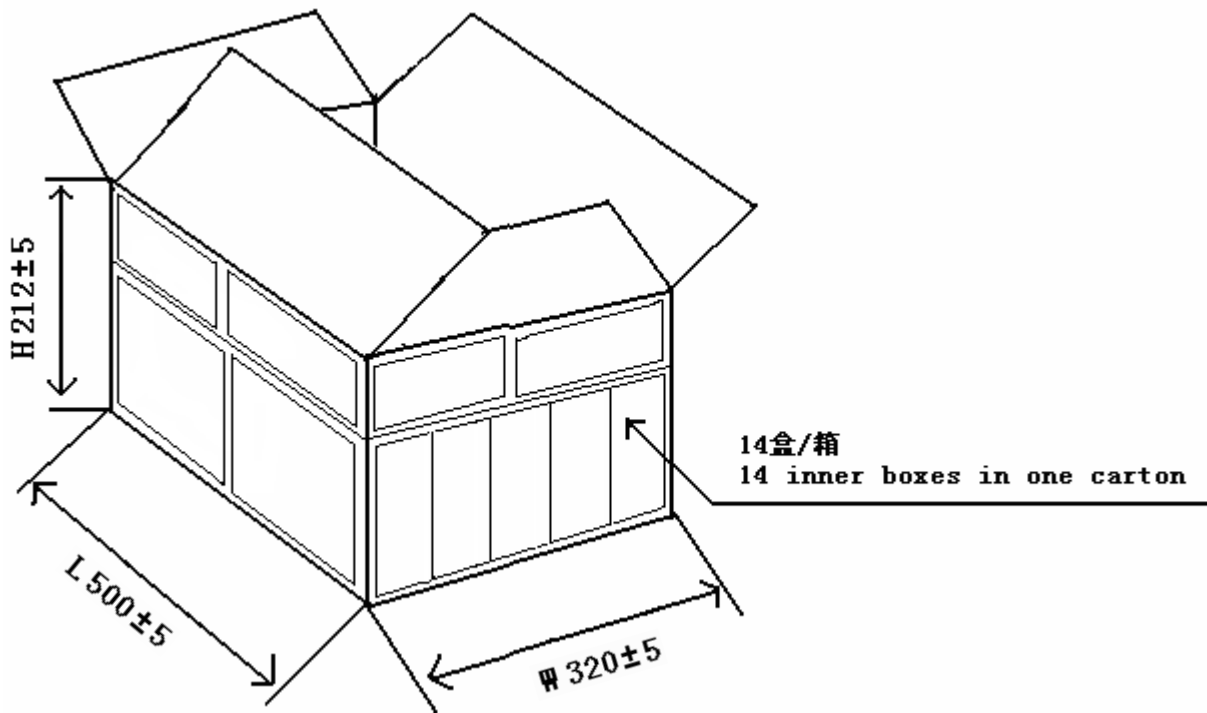

Inner Box plane

solid

